

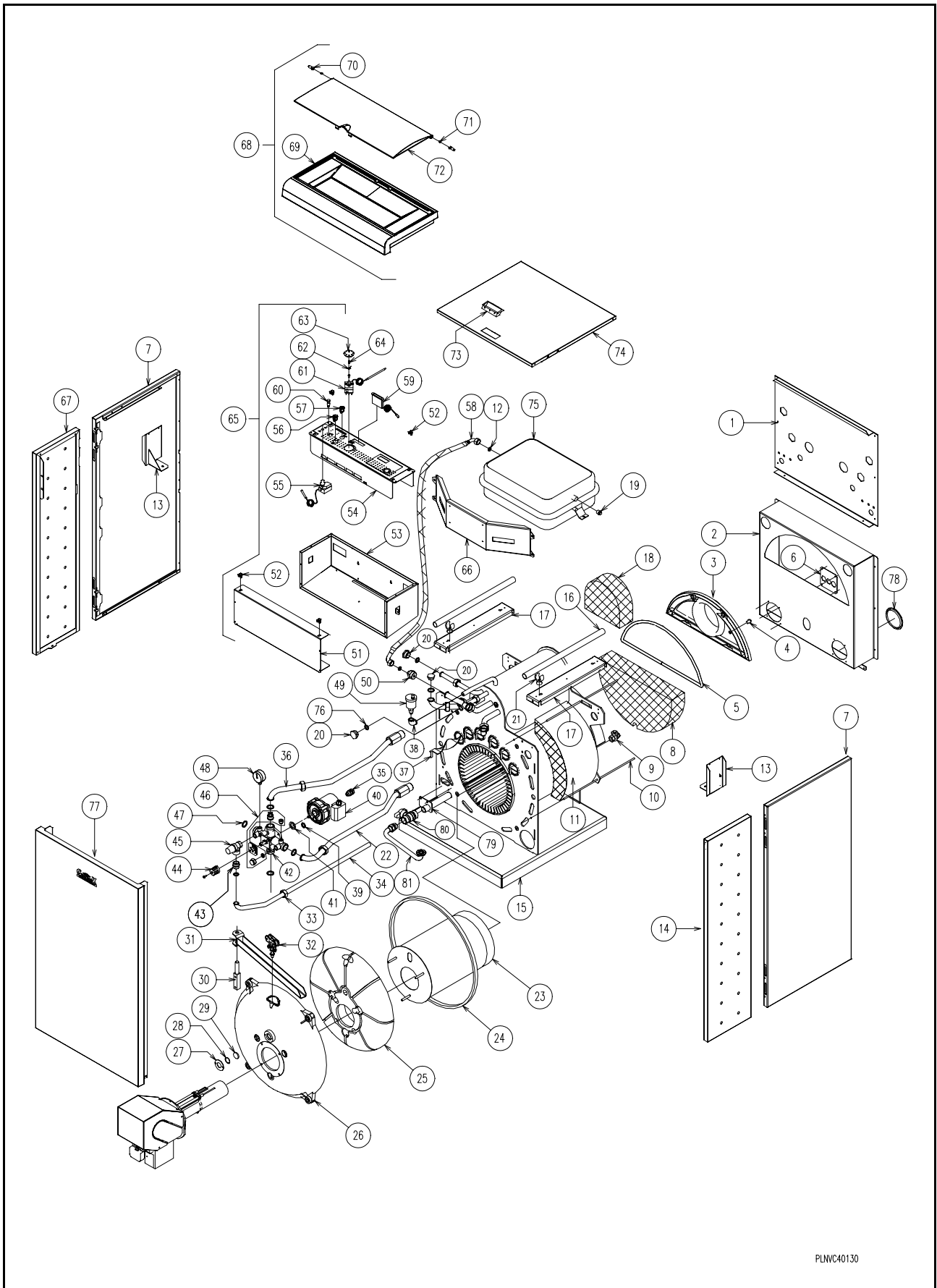

























































ZNVC4.0120-ZNVC4.0130





















NOVALITHE GAZ 20-30 C

1	 REF : 87168357450 ARRIERE SUP. GRIS ZNV C
2	 REF : 87168357110 ARRIERE INF. GRIS ZNV 20S
2	 REF : 87168357590 ARRIERE INF. GRIS ZNV 30/40
3	 REF : 87168303540 COUVERCLE FUMEE 139/150 ASTRANE 30 CHEM.
3	 REF : 87168303550 COUVERCLE FUMEE 120/125 ASTRANE 20 CHEM.
4	 REF : 87168032770 BOUCHON FONTE NOIRE M1/4
5	 REF : 87168401080 TRESSE DE VERRE D.10 LG1.2M
6	 REF : 87168313510 PATTE BLOCAGE AR.GRIS TUBES FIOUL/GAZ
7	 REF : 87168357440 COTE ARIERE D/G GRIS ZNV 30/30C
8	 REF : 87168307960 ISOLANT ARR.C.DE CHAUFFE ASTRANE
9	 REF : 87168005840 ROBINET VIDAN SS BOUCHON F1/2-M1/2
10	 REF : 87168309320 MAINTIEN ISOLANT CDC ASTRANE 30
10	 REF : 87168309330 MAINTIEN ISOLANT CDC. ASTRANE 20
11	 REF : 87168307940 ISOLANT C.DE CHAUFFE ASTRANE 30
11	 REF : 87168307950 ISOLANT C.DE CHAUFFE ASTRANE 20
12	 REF : 87168068920 JOINT QUALITE AFM34 D.18,6x12 ép. 2 mm
13	 REF : 87168357520 PATTE SUP.VASE EQUIPEE NOVALITHE C
14	 REF : 87168357500 COTE AV.DROIT GRIS NOVALITHE C
15	 REF : 87168310770 CORPS DE CHAUFFE EQUIPE ASTRANE 20

15	 REF : 87168310780 CORPS DE CHAUFFE EQUIPE ASTRANE 30
16	 REF : 87168271740 TUBE PVC 25x1,5 L: 480mm
17	 REF : 87168350790 REGLETTE PLIE NOVALITHE 30C
17	 REF : 87168350800 REGLETTE PLIEE NOVALITHE 20
18	 REF : 87168308220 ISOLANT ARR.SUP.C.D.C. ASTRANE
19	 REF : 87168032780 BOUCHON EN FONTE MALE 3/8
20	 REF : 87168250960 BOUCHON LAITON M 3/4
21	 REF : 87168271750 FIXATION OBO SIPHON 22
22	 REF : 87168309010 RET.RADIATEUR GRIS ASTRANE
23	 REF : 87168307520 POT DE FOYER ASTRANE 20
23	 REF : 87168307530 POT DE FOYER ASTRANE 30
24	 REF : 87168389460 KIT TRESSE 18x18 LG 1620 PORTE BRUL.AST/NOV
25	 REF : 87168303920 ISOLANT PORTE BRULEUR NOVALITHE / ASTRANE
26	 REF : 87168309070 PORTE FONTE EQUIPEE ASTRANE
27	 REF : 87168293360 RONDEL.VISE FLAMME GALVA TL - OLIO 1500
28	 REF : 87168006920 RONDELLE ELASTIQUE INOX A2 -D30,4x25,5x0,3
29	 REF : 87168005820 HUBLOT BOROSILICATE D.30X5
30	 REF : 87168305750 AXE DE CHARNIERE ASTRANE
31	 REF : 87168308890 POTENCE GRISE ASTRANE

32	 REF : 87168309180 ROULETTE ACIER SPORTUB 235A
33	 REF : 87168030240 ECROU HEX.AGONAL POUR COLLET BATTU 3/4 -D.19
34	 REF : 87168308210 TUBE EVACUATION SOUPAPE ASTRANE
35	 REF : 87168315540 LANCEUR CIRCULATEUR GRUNDFOS
36	 REF : 87168309030 DEP.RADIAT.CIRC.1 GRIS ASTRANE
37	 REF : 87168133470 TURBULATEUR TL 35
37	 REF : 87168204440 TURBULATEUR COMPLET TL20
38	 REF : 87168036200 COUDE FONTE NOIRE 90° F3/8-F3/8
39	 REF : 87168315670 JOINT TORIQUE EPDM D.18x2,5 80 SHORE A
40	 REF : 87168315170 MOTEUR CIRCULATEUR UPS 15-50 MBP OU PM
41	 REF : 87168315660 JOINT TORIQUE EPDM D.25,07x2,62 80 SHORE A
42	 REF : 87168302350 MONOBLOC VANNE/POMPE ST2061G00
43	 REF : 87168030230 MAMELON EGAL LAITON M3/4-M3/4 (STRIE)
44	 REF : 87168175520 BOUTON CDE DE VANNE
45	 REF : 87168505150 SOUPAPE DE SECURITE EAU
46	 REF : 87168307800 ACCESSOIRES BLOC VANNE
47	 REF : 87168038900 JOINT QUALITE AFM34 D.24 X 17 X 3
48	 REF : 87168001720 MANOMETRE CIRCUL 0/4BAR PRISE 6H 1/4
49	 REF : 87168193470 PURGEUR AUTO. 3/8 AV VALVE ISOLEMENT

50	 REF : 87168307880 REDUCTION LAITON M1/2-M1
51	 REF : 87168350120 CAPOT PROTECTION PLIE ZNV
52	 REF : 87168159010 CLIPS FERMETURE RAPID PE EP 0,9 A 1,2 (C4406)
53	 REF : 87168357310 COFFRET ELECT. GRIS ZNV
54	 REF : 87168357530 TALEAU CDE. + LEXAN NOVALITHE C
55	 REF : 87168419900 THERMOSTAT SECU LIM 110°C - CAP 2M (R)
56	 REF : 87168249030 INVERSEUR UNIPOLAIRE ROND D.23
57	 REF : 87168249040 INTER UNIPOLAIRE D.23 LUMINEUX VERT
58	 REF : 87168344530 FLEXIBLE F1/2-F1/2-L630 ASTRANE
59	 REF : 87168011350 THERMOMETRE RECT HORIZ 69x14 LG CAPIL.1500 MM
60	 REF : 87168032440 VOYANT ROUGE 230V TETE PLATE RONDE
61	 REF : 87168109720 THERMOSTAT REG.20/80°C CAP 1,5M INV. (+2 VIS)
62	 REF : 87168188710 BUTEE DE BOUTON POUR BOUTON THERMOSTAT
63	 REF : 87168188000 BOUTON AQUASTAT GEMINOX
64	 REF : 87168316140 VIS BUTEE THERMOSTAT M4x5 LAITON
65	 REF : 87168352500 TABLEAU CDE. EQUIPE NOVALITHE C FIOUL
66	 REF : 87168357460 SUPPORT COFFRET GRIS NOVALITHE C
67	 REF : 87168357480 COTE AVANT GAUCHE GRIS NOVALITHE C
68	 REF : 87168350770 FACADE PLASTIQUE COMPL. NOVALITHE

70	 REF : <u>87168352020</u> AXE VOLET NOVALITHE
71	 REF : <u>87168352040</u> RESSORT AXE NOVALITHE
72	 REF : <u>87168352030</u> VOLET NOVALITHE
73	 REF : <u>87168189840</u> POIGNEE CLIPSABLE NOIRE PR EP1 82.5x25.5 (P2-41)
75	 REF : <u>87168354790</u> KIT VASE D'EXPANSION THISION B120
76	 REF : <u>87168038900</u> JOINT QUALITE AFM34 D.24 X 17 X 3
77	 REF : <u>87168357130</u> FACADE GRISE ZNV
78	 REF : <u>87168104350</u> BOUCHON PLASTIQ MAL92 NOIR
79	 REF : <u>87168313540</u> TUBE GAZ AMONT GRIS ASTRANE 20
80	 REF : <u>87168334980</u> VANNE PAPILLON JAUNE POUR GAZ F3/4-F3/4 (R)
81	 REF : <u>87168335080</u> TUBE ARRIVEE GAZ BRASE ASTRANE GAZ (R)