

ZTHH4.0100-ZTHH4.0200 - (AV)

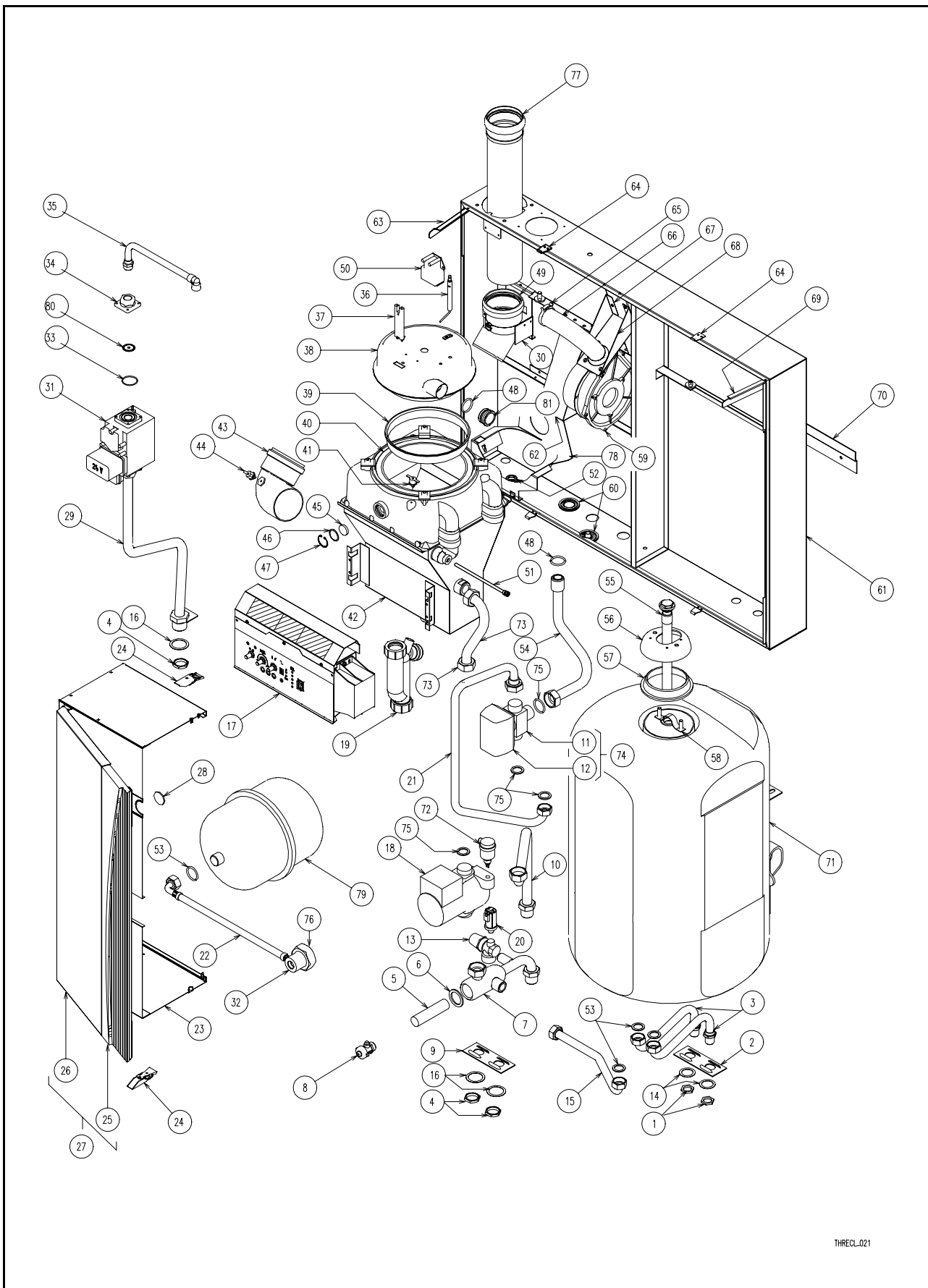



THR5CL\_021



















THR 5-25 M75 H jusqu'au numéro N° 019910654







1	 <a href="#">REF : 87168030680</a> ECROU PAL 3/4
2	 <a href="#">REF : 87168214650</a> PATTTE BLOCAGE SANITAIRE
3	 <a href="#">REF : 87168185760</a> TUBE SANITAIRE M75 H INOX
4	 <a href="#">REF : 87168214520</a> CONTRE-ECROU LAITON 1
5	 <a href="#">REF : 87168244950</a> FILTRE RETOUR CHAUFFAGE INOX Z50025002 26,8x110
6	 <a href="#">REF : 87229359120</a> JT.CIRCULATEUR (X10)
7	 <a href="#">REF : 87168214420</a> BLOC RETOUR CHAUF. GRIS THR S
8	 <a href="#">REF : 87168115900</a> ROBINET VIDAN AV BOUCHON M1/2-M3/4
9	 <a href="#">REF : 87168214660</a> PATTE BLOCAGE CHAUFFAGE THR
10	 <a href="#">REF : 87168214560</a> DEPART CHAUF. GRIS THR S
11	 <a href="#">REF : 87168138030</a> VANNE 3 VOIES MAL1 DEM
12	 <a href="#">REF : 87168201160</a> MOTEUR HONEYWELL. VC 4013 CABLE
13	 <a href="#">REF : 87168505150</a> SOUPAPE DE SECURITE EAU
14	 <a href="#">REF : 87168214920</a> RONDELLE DE PROTECTION 03/04/2014
16	 <a href="#">REF : 87168214910</a> RONDELLE DE PROTECTION 1
18	 <a href="#">REF : 87168185560</a> CIRCULATEUR GRUNDFOS 230 UPS15-50/130 AOS 3H
19	 <a href="#">REF : 87168236550</a> SIPHON
20	 <a href="#">REF : 87168409530</a> KIT REMPLACEMENT THR INDICATEUR PRESSION
21	 <a href="#">REF : 87168205520</a>

	ENTREE BALLON BRASE THR M75 H
22	 <a href="#">REF : 87168206790</a> FLEXIBLE MALE 1/4
23	 <a href="#">REF : 87168267350</a> JAQUETTE THR M75 H PORTE/POIGNEE BLANCHE
24	 <a href="#">REF : 87168318750</a> SAUTERELLE VERROUILLABLE (SANS GACHE) Acier
25	 <a href="#">REF : 87168157300</a> POIGNEE PORTE ABS BLANC 90.22.90.79.0.B25
26	 <a href="#">REF : 87168138070</a> PORTE BLANCHE NU MZS/THRS
28	 <a href="#">REF : 87168030700</a> HUBLOT VERRE CARRE 33x33 Ep:3
29	 <a href="#">REF : 87168214370</a> ALIMENTATION GAZ GRIS THR
31	 <a href="#">REF : 87168384120</a> KIT REMPLACEMENT VDA/VDU 24 V - THR (R)
32	 <a href="#">REF : 87168205950</a> BRIDE ROBINET+VASE EXPAN THR
33	 <a href="#">REF : 87168122900</a> JOINT POUR VANNE VDA REF 428095430
35	 <a href="#">REF : 87168123480</a> TUBE GAZ BRULEUR MZ 5/25
36	 <a href="#">REF : 87168129500</a> ELECTRODE IONISA COURTE 20 (prévoir silicone haute température-87168187270)
37	 <a href="#">REF : 87168166730</a> ELECTRODE ALLUM COURTE ANTI-PARASITEE COSSE 2,8 (prévoir silicone haute température-87168187270)
38	 <a href="#">REF : 87168234810</a> KIT BRULEUR 5-25 GP (STC)THR/THRI/THI (propane)
38	 <a href="#">REF : 87168264730</a> KIT BRULEUR 5-25 GN (STC) THR/THRI/THI
39	 <a href="#">REF : 87168128640</a> JUPE DE BRULEUR (MODELES 9 / 25)
40	 <a href="#">REF : 87168265720</a>

	ANNEAU TRESSE DE VERRE D10 ; LG : 680 mm ; 750°C
41	 <a href="#">REF : 87168154550</a> KLICSON 100 REARM AUTO 75
42	 <a href="#">REF : 87168213150</a> CORPS DE CHAUFFE INOX T HR M75 H
43	 <a href="#">REF : 87168120530</a> COUDE A 90° D.80 AVEC SONDE
44	 <a href="#">REF : 87168154540</a> KLICSON 85 REARM AUTO 75
45	 <a href="#">REF : 87168319900</a> VISE FLAMME < 5970 312 000 893
45	 <a href="#">REF : 87168523260</a> > 5970 312 000 893
46	 <a href="#">REF : 87168006920</a> RONDELLE ELASTIQUE INOX A2 -D30,4x25,5x0,3
47	 <a href="#">REF : 87168010510</a> CIRCLIPS INTERIEUR D.30 ZINGUE BLANC
48	 <a href="#">REF : 87168010050</a> JOINT TORIQUE ETHYL/PROP D.29,32X3,6 70 SHORE
49	 <a href="#">REF : 87168203660</a> COUDE D.80 45° EQUIPE (PRISE 1/4)
50	 <a href="#">REF : 87168150200</a> TRANSFORMATEUR ALLUMAGE 12-24 V (THR)
51	 <a href="#">REF : 87168150220</a> SONDE CHAUDIERE QAK23.122 (C.C)
52	 <a href="#">REF : 87168030710</a> PASSE-FIL SAREL
53	 <a href="#">REF : 87168038900</a> JOINT QUALITE AFM34 D.24 X 17 X 3
54	 <a href="#">REF : 87168193530</a> DEP. C.DE CHAUF.GRIS THRS
55	 <a href="#">REF : 87168413690</a> ANODE + JOINT
56	 <a href="#">REF : 87168294770</a> BRIDE DE TRAPPE VISITE

57	 <a href="#">REF : 87168101870</a> JOINT TRAPPE DE VISITE
58	 <a href="#">REF : 87168199840</a> TRAPPE SAV ANODE
58	 <a href="#">REF : 87168263820</a> TRAPPE POUR BALLON SANS ANODE
59	 <a href="#">REF : 87168289870</a> VENTILATEUR + CABLAGE THR 5-25
60	 <a href="#">REF : 87168236540</a> JOINT À SOUFFLET
61	 <a href="#">REF : 87168334690</a> KIT CHASSIS EQUIPE M75H THISION/THRI/THI/THR
63	 <a href="#">REF : 87168182340</a> CONSOLE GAUCHE PLIEE GALVANISEE
64	 <a href="#">REF : 87168141390</a> CROCHET DE BRIDAGE (CHASSIS)
65	 <a href="#">REF : 87168183920</a> COLLIER DE SERRAGE
66	 <a href="#">REF : 87168166810</a> DURITE ENTRE BRULEUR/VENTILATEUR
67	 <a href="#">REF : 87168175690</a> SUPPORT VENTILATEUR PEINT BLANC
68	 <a href="#">REF : 87168175700</a> BRIDE DE FIXATION DU VENTILATEUR
69	 <a href="#">REF : 87168182330</a> CONSOLE DROITE PLIEE GALVANISEE
71	 <a href="#">REF : 87168416200</a> BALLON ECS 75L (PASSIVE)
72	 <a href="#">REF : 87168246350</a> PURGEUR AUTO WATTS AVEC VALVE ISOLEMENT
73	 <a href="#">REF : 87168192520</a> TUBE ENTREE COLLECTEUR (TOUS MOD. SAUF DUO/DC)
74	 <a href="#">REF : 87168204820</a> MOTEUR HONEYWELL + VANNE 1
75	 <a href="#">REF : 87168038890</a> JOINT QUALITE AFM34 D.30 x 21 x ep:3 mm
76	 <a href="#">REF : 87168030100</a>

	ECROU 1 1/2 - acier bichro jaune 73815022301
77	 <a href="#">REF : 87168168100</a> TUBE PPS REDUIT D 80/75 LG: 360 mm
78	 <a href="#">REF : 87168205930</a> SUP. VASE EXPANS. BLANC THR
79	 <a href="#">REF : 87168035200</a> VASE EXPANSION 8L 3/4 CYLIND. D.197 VALVE LAT
80	 <a href="#">REF : 87168233430</a> OPERCULE D.5.8 VANNE VDA (PROPANE)
81	 <a href="#">REF : 87168125300</a> OPERCULE AIR Ø 29 (pour bruleur X00.18792 uniquement)
81	 <a href="#">REF : 87168233740</a> OPERCULE AIR Ø 27 (pour bruleur X00.23351 uniquement)